

MODEL 3102 PVC HORIZONTAL SLIDING WINDOW WITH FLANGE "IMPACT"

GENERAL NOTES

1. THIS PRODUCT HAS BEEN EVALUATED AND IS IN COMPLIANCE WITH THE 2004 FLORIDA BUILDING CODE EXCLUDING THE "HIGH VELOCITY HURRICANE ZONE".
2. PRODUCT ANCHORS SHALL BE AS LISTED AND SPACED AS SHOWN ON DETAILS. ANCHOR EMBEDMENT TO BASE MATERIAL SHALL BE BEYOND WALL DRESSING OR STUCCO.
3. WHEN USED IN WIND-BORNE DEBRIS REGIONS EXCLUDING WIND ZONE 4 (> 140 MPH WIND SPEED) THIS PRODUCT COMPLIES WITH SECTION 1609.1.4 OF THE FLORIDA BUILDING CODE AS AN IMPACT RESISTANT PRODUCT AND DOES NOT REQUIRE THE USE OF AN EXTERNAL IMPACT RESISTANT COVERING. THIS PRODUCT DOES NOT MEET THE REQUIREMENTS FOR ENHANCED PROTECTION OF ESSENTIAL FACILITIES AS DEFINED IN ASTM E1996.
4. FOR 2X STUD FRAMING CONSTRUCTION, ANCHORING OF THESE UNITS SHALL BE THE SAME AS THAT SHOWN FOR 2X BUCK MASONRY CONSTRUCTION.
5. CONDITIONS NOT COVERED BY THIS DRAWING ARE SUBJECT TO FURTHER ENGINEERING ANALYSIS.

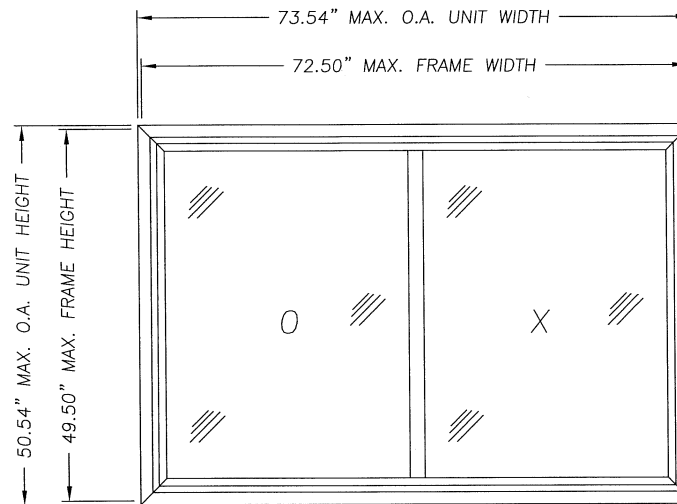

TABLE OF CONTENTS	
1	TYPICAL ELEVATION, DESIGN PRESSURES & GENERAL NOTES
2	VERTICAL & HORIZONTAL CROSS SECTIONS
3	BUCK & FRAME ANCHORING
4	BILL OF MATERIALS, COMPONENTS & GLAZING DETAIL

OVERALL UNIT DIMENSION	OVERALL FRAME DIMENSION	OVERALL DAY LIGHT DIMENSION	GLASS TYPE	DESIGN PRESSURE (PSF)	
				POSITIVE	NEGATIVE
73.54"	72.50"	32.75"	1/8" ANN.	+50.0	-50.0
X	X	X	- AIR -		
50.54"	49.50"	43.25"	1/8" ANN. / SAFLEX / 1/8" ANN.		

Documents Prepared By: BUILDING CONSULTANTS, INC.
P.O. Box 230 Valrico FL 33595
Phone No.: 813.659.9197
Florida Board of Professional Engineers
Certificate Of Authorization No. 9813
Wendell W. Ramsay 6-21-06
Wendell W. Ramsay, P.E. No. 54158

PRODUCT: MODEL 3102 HORIZONTAL SLIDING WINDOW WITH FLANGE "IMPACT"
PART OR ASSEMBLY: TYPICAL ELEVATION, DESIGN PRESSURES & GENERAL NOTES

NO.	DATE	REVISIONS
1	06/21/06	REVISE GLASS OPTION
		EW
		BY

DATE: 02/28/06
SCALE: N.T.S.
DWG. BY: AEM
CHK. BY: WWH
DRAWING NO.: FL-884
SHEET 1 OF 4

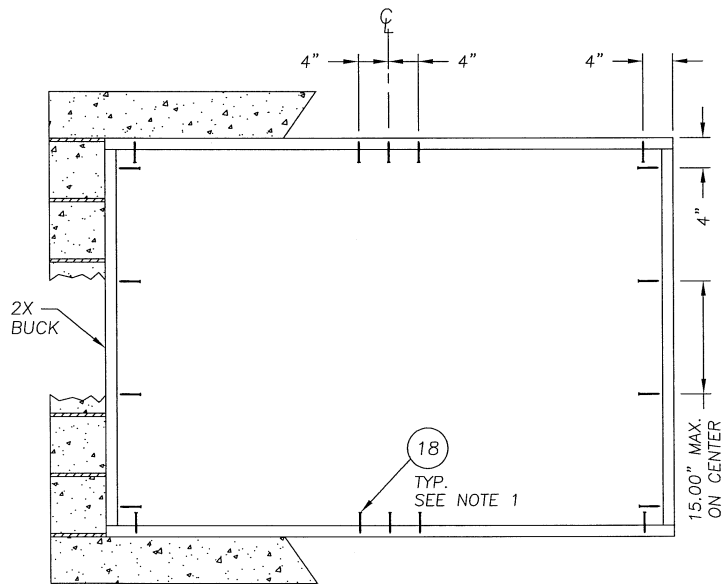

BUCK ANCHORING

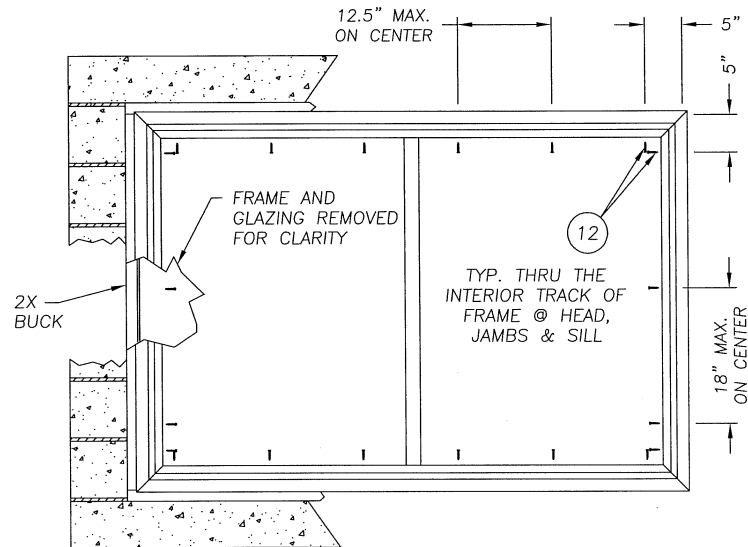

FRAME ANCHORING

NOTES:

1. 3/16" TAPCONS REQUIRE A MINIMUM 2" CLEARANCE TO MASONRY EDGES AND A MINIMUM 2-1/4" CLEARANCE TO ADJACENT TAPCONS.

Documents Prepared By:
RW BUILDING CONSULTANTS, INC.
 P.O. Box 230 Valrico FL 33595
 Phone No.: 813.659.9197
 Florida Board of Professional Engineers
 Certificate Of Authorization No. 9813
Wendell W. Haney 02/21/06
 Wendell W. Haney, P.E., No. 754158

PRODUCT: MODEL 3102
 HORIZONTAL SLIDING WINDOW
 WITH FLANGE "IMPACT"
 PART OR ASSEMBLY:
 BUCK & FRAME
 ANCHORING

NO.	DATE	REVISION	BY
1	06/21/06	REVISE GLASS OPTION	EW

DATE: 02/28/06
 SCALE: N.T.S.
 DWG. BY: AEM
 CHK. BY: WWH
 DRAWING NO.: FL-884
 SHEET 3 of 4

Item	Description	Material
1	EXTRUDED VINYL MASTER FRAME BY VEKA INC. *	RIGID PVC
2	EXTRUDED VINYL KEEPER RAIL BY VEKA INC. *	RIGID PVC
3	EXTRUDED VINYL SILL TRACK BY VEKA INC. *	RIGID PVC
4	EXTRUDED VINYL LOCK RAIL BY VEKA INC. *	RIGID PVC
5	EXTRUDED VINYL SASH STILE BY VEKA INC. *	RIGID PVC
6	EXTRUDED VINYL 3/4" GLAZING BEAD BY VEKA INC. *	RIGID PVC
7	EXTRUDED ALUMINUM FRAME REF. BY VEKA INC.	ALUMINUM
8	EXTRUDED ALUMINUM MULLION REF. BY VEKA INC.	ALUMINUM
9	ROLL FORMED STEEL SASH REF. BY VEKA INC.	STEEL
10	ROLL FORMED STEEL LOCK RAIL REF. BY VEKA INC.	STEEL
11	PURFECT GLAZE SEALANT 938a BY NATIONAL ADHESIVES	SEALANT
12	#10 x 1 1/4" PPH SMS	STEEL
13	3/4" INSULATED GLASS INTERLAYER SAFLEX BY SOLUTIA 1/8" ANN.- AIR - /1/8" ANN./ .090" SOLUTIA SAFLEX /1/8" ANN.	GLASS
14	SILICONE SEALANT	SILICONE
15	1/4" MAX. SHIM SPACE	WOOD
16	2X BUCK	WOOD
17	MASONRY	CONC.
18	3/16" X 2-3/4" TAPCON	STEEL
19	SCREEN	-
20	WEATHER PILE .187" x .280" BY AMESBURY	-
21	SCREW HOLE COVER CAP	PVC

* THE APPROVED WHITE RIGID PVC EXTERIOR EXTRUSIONS FOR WINDOWS ARE TO BE PRODUCED BY EXTRUDERS LICENSEES IN "AAMA CERTIFICATION PROGRAMS FOR RIGID PVC EXTRUSIONS".

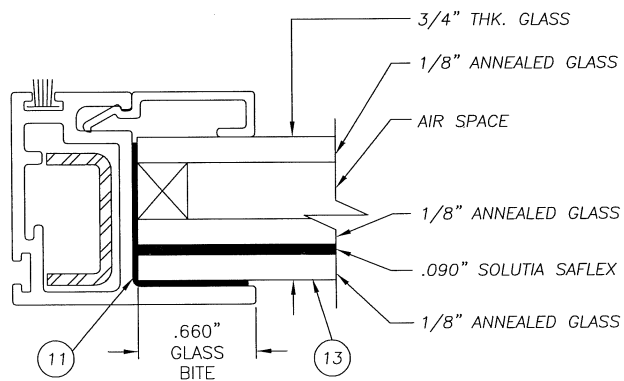

GLAZING DETAIL

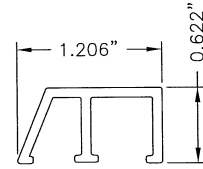

3 SILL TRACK
VEKA #DS3008

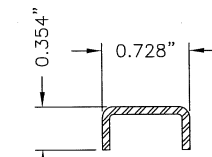

9 SASH REINFORCEMENT
VEKA #RFSH45 SOM

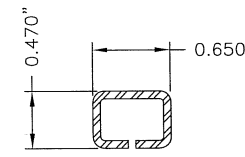

10 LOCK RAIL REINF.
VEKA #RFSH46 SOM

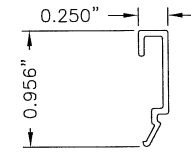

6 GLAZING BEAD
VEKA #BV75

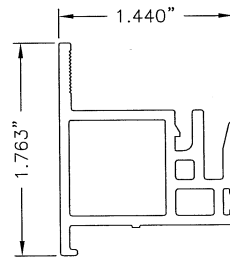

2 KEEPER RAIL
VEKA #SH34

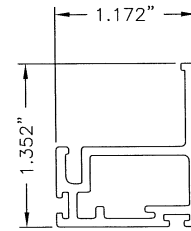

5 SASH STILE
VEKA #SH45

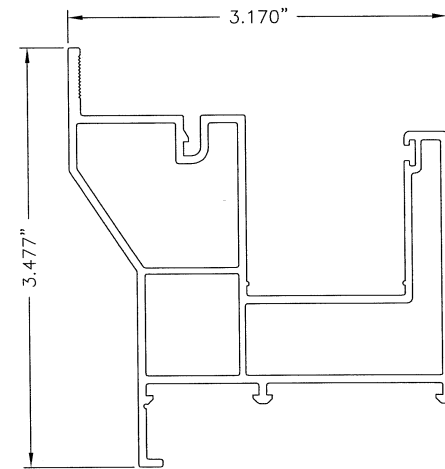

1 MASTER FRAME
VEKA #PI3101

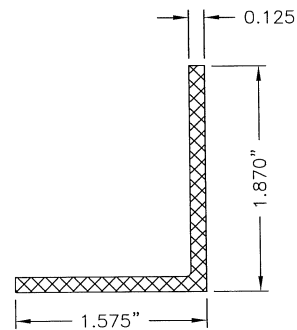

7 FRAME REINFORCEMENT
VEKA #RFSSA2101 AOM

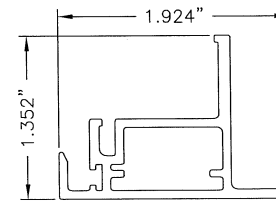

4 LOCK RAIL
VEKA #SH46

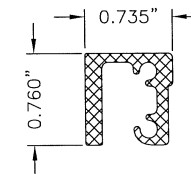

8 MULLION REINFORCEMENT
VEKA #RFSH34 AOM

Documents Prepared By: **RW** BUILDING CONSULTANTS, INC.
 P.O. Box 230 Valrico FL 33595
 Phone No.: 813.659.9197
 Florida Board of Professional Engineers
 Certificate Of Authorization No. 9813
 Wendell W. Haney, P.E. 380-341-58

PRODUCT: MODEL 3102 HORIZONTAL SLIDING WINDOW WITH FLANGE "IMPACT"
 PART OR ASSEMBLY: BILL OF MATERIALS, COMPONENTS & GLAZING DETAIL

NO.	DATE	BY	REVISIONS
1	06/21/06	EW	REVISE GLASS OPTION

DATE: 02/28/06
 SCALE: N.T.S.
 DWG. BY: AEM
 CHK. BY: WWH
 DRAWING NO.: FL-884
 SHEET 4 OF 4

\\rwbcsrv\wbc\proj 901 - 1000\p13\F-884 REV1\FL-884-4.dwg